





**READ ME FIRST!**  
**DSL setup instructions**  
**For Comtrend ADSL Modem/Router.**

	Adsl Modem
	RJ-45 Cable
	RJ-11 Cable
	Power adapter

Included with your DSL modem/router you will find a DSL line filter. This filter should be plugged directly into the wall phone jack (**page 4**). The filter has 2 jacks, one for the line to the phone and one for the line to the DSL modem. Each jack is labeled accordingly. Follow the directions on the following pages to setup your computer and setup your modem for wireless use.

**NOTE: For wired connections only! For Wireless Setup please see page 3**

Verify that your PC or Apple is configured to accept an IP address via DHCP, by:

- **Windows XP:** click on Start -> Run -> type in "ncpa.cpl" click "OK". Right click on "Local Area Connection" Left click on Properties then double click on "Internet Protocol (TCP/IP)" -> Continue to step **(a)**
- **Windows Vista/7:** Click on "Start" then type ncpa.cpl in the search window and press the enter key on your keyboard. Right click on "Local Area Connection" Left click on "Properties" then double click on "Internet Protocol version 4 (TCP/IPv4)"-> Continue to step **(a)**

**(a)** Click on the circle next to "Obtain an IP address automatically"

Click OK or Close

Open up your favorite web browser or email client and enjoy your broadband internet connection.

- **OS X operating system:** Click on the apple logo in the upper left corner, select "System Preferences." Click "Network." Next to the word "Show" select in the drop down menu "Built-in Ethernet." Under the TCP/IP tab verify that, next to the phrase "Configure IPv4" in the drop down menu, "Using DHCP" is selected. You should be able to connect.

When all of your connections are made, your connections should look like this:

## Rear View

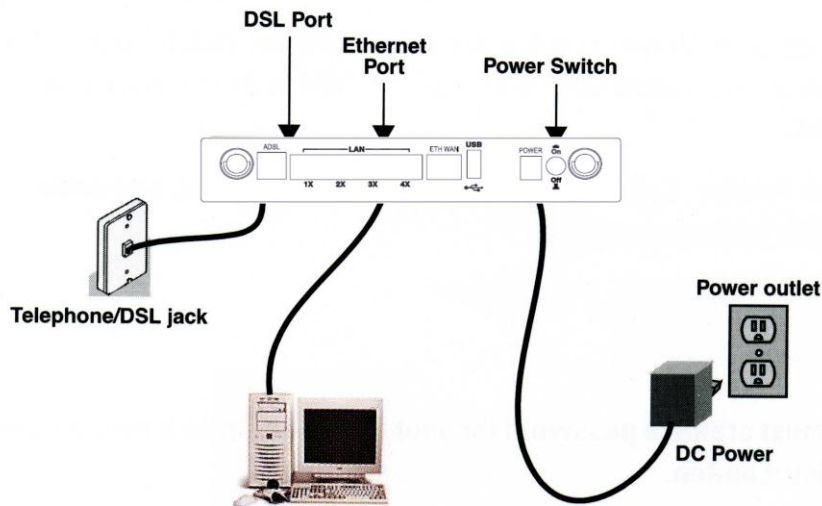

---

**Note:** You will need an extra hub or switch if more Ethernet ports are needed.

---

### To access your Comtrend ADSL Modem for Custom Configurations.

#### **Warning: for advanced users only!**

To log into your Comtrend ADSL modem, open your web browser - in the top address bar type <http://192.168.1.1>, it will ask you for a username and password. The username is root, the password is your DSL phone number with a (-) example: 467-0000. You can make any changes you may think are appropriate. If you lose DSL connectivity, push the reset button for 10 seconds, this will reset the modem to Sisqtel.net default settings.

## Comtrend CT-5364A Modem/Router Wireless Setup

1. With the Ethernet (yellow) cable plugged into your computer, open your Web Browser.
2. In the URL box on top put <http://192.168.1.1> click "Enter."
3. Next you should be asked to enter a user name and password. Username is root, Password is your phone number with a "-" example 467-0000
4. Click on "Wireless"
5. Click on the box "Enable Wireless"
6. SSID is the name you will see from your wireless devices. Enter whatever you would like to see. Examples (Home Network; Wireless Network)
7. Leave all other boxes unchecked unless you know what they do, thanks.
8. Click on "Save/Apply"
9. **RECOMMENDED:** If you would like your wireless connection to be password protected click on "Security"
10. Click on the drop down menu next to "Network Authentication" and select "Mixed WPA2/WPA -PSK"
11. "WPA Pre-shared Key" is where you put the password. It must be 8 characters or more.
12. Click on "Save/Apply"

You can now unplug the yellow "Ethernet" cable. From the wireless program on your computer you should see your SSID. If asked for a password enter the password.

**Make sure you use the Ethernet cable OR the wireless connection, never both on one computer as it may interrupt your internet service.**

**This is the Screen you should see when putting in a passphrase.**

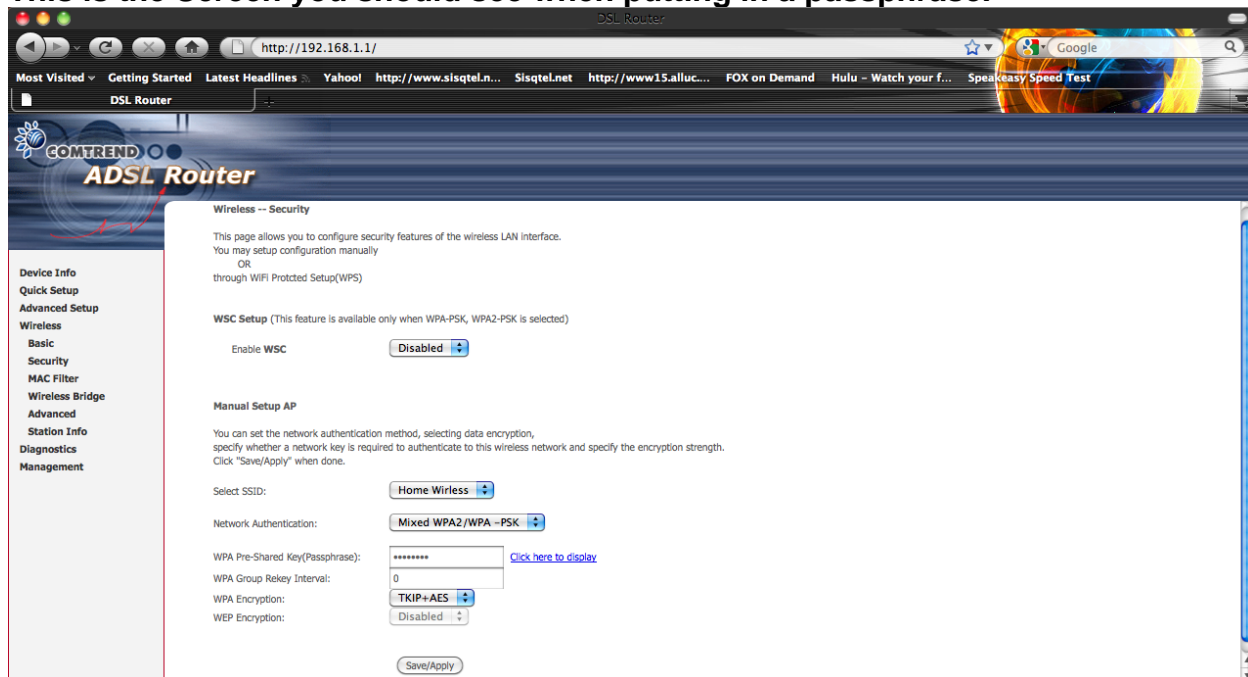

All Phone lines must be filtered for the best DSL service. First plug your DSL two port filter into your wall jack. Be sure to plug the phone side of your filter into your phone and the computer screen side of the filter (DSL/HPN) into your DSL modem. If you need additional filters for your satellite receiver or other phones, please call us (530-467-6000 or 1-866-467-6001) to place your order.

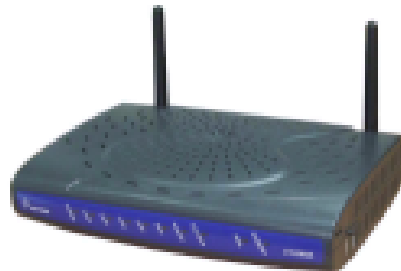



*A Tradition of Excellence Since 1896*

---

30 Telco Way • P.O. Box 157 • Etna, CA 96027-0157  
Phone (530) 467-6000 • (866) 467-6001 • Fax (530) 467-6401

## **Warranty: Comtrend CT-5364A**

Should your Comtrend CT-5364A aDSL modem, purchased from Siskiyou Telephone, fail within the first 12 months from *original* purchase date, we will replace the modem with, at our option, a new or reconditioned modem free of charge. The replacement modem will be warranted through the 12<sup>th</sup> month of the *original* modem's purchase date.

The failed modem must be returned to Siskiyou Telephone along with all power supplies and cables. If modem is not returned, you will be charged the current sales amount.

Obvious abuse or neglect of modem voids this warranty. It is the customer's responsibility to protect computers and modems from lightning or electrical damage.